

**Applicable Socket:**  
SO-1064-001  
SM-1000-003

**Application Notes:**  
101  
102  
103A  
007  
023

• Contact arrangement	2 PDT
• Qualified to (MIL Version)	MIL-PRF-83536/1 & /2

### PRINCIPLE TECHNICAL CHARACTERISTICS

• Contacts rated at	Low level, 28 Vdc and 115/200 Vac, 400Hz, 3Ø, case grounded
• Weight	0.034 lbs. max
• Dimensions	0.41 in x 0.81 in x 0.64 in
• Special models available upon request	
• Hermetically sealed, corrosion resistant metal can	

### CONTACT ELECTRICAL CHARACTERISTICS

Contact rating per pole and load type [1]	Load current in Amps		
	28 Vdc	115 Vac, 400 Hz, 1Ø	115/200 Vac, 400 Hz, 3Ø
Resistive	5	5	5
Inductive [2]	3	5	5
Motor	2	3	3
Lamp	1	1	-
Overload	20	30	30
Rupture	25	40	40
Low level [3]	-	-	-
Time current characteristics [4]	-	-	-

## COIL CHARACTERISTICS (Vdc)

CODE	A	B	C	M	N [5]	R [5]	V [5]
Nominal operating voltage	28	12	6	48	28	12	6
Maximum operating voltage	29	14.5	7.3	50	29	14.5	7.3
Maximum pickup voltage							
- Cold coil at +125° C	18	9	4.5	36	18	9	4.5
- During high temp test at +125° C	19.8	9.9	5	38	19.8	9.9	5
- During continuous current test at +125° C	22.5	11.25	5.7	42	22.5	11.25	5.7
Maximum drop-out voltage	7	4.5	2.5	14	7	7	2.5
Coil resistance in $\Omega$ $\pm 10\%$ at +25° C except types "C" and "V" +20%, - 10% $\pm 20\%$	500	125	20	1600	500	125	20

## GENERAL CHARACTERISTICS

Temperature range	-70°C to +125°C
Minimum operating cycles (life) at rated load	100,000
Minimum operating cycles (life) at 25% rated load	400,000
Dielectric strength at sea level	
- All circuits to ground and circuit to circuit	1000 Vrms
- Coil to ground	1000 Vrms
Dielectric strength at altitude 80,000 ft	500 Vrms [6]
<b>Insulation resistance</b>	
- Initial (500 Vdc)	100 M $\Omega$ min
- After environmental tests (500 Vdc)	50 M $\Omega$ min
Sinusoidal vibration (A, D, and J mounting)	0.12 d.a. / 10 to 70 Hz 30G / 70 to 3000 Hz
Sinusoidal vibration (E mounting in track)	0.06 d.a. / 10 to 57 Hz 10G / 57 to 500 Hz 20G / 500 to 3000 Hz
Sinusoidal vibration (G mounting)	0.12 d.a. / 10 to 57 Hz 20G / 57 to 3000 Hz
<b>Random vibration</b>	
- Applicable specification	MIL-STD-202
- Method	214
- Test condition – A, D, and J mounting	1G (0.4G <sup>2</sup> /Hz, 50 to 2000 Hz)
- Test condition – E and G mounting (E in track)	1E (0.2G <sup>2</sup> /Hz, 50 to 2000 Hz)
- Duration	15 minutes each plane
Shock (A, D, and J mounting)	200G / 6 ms
Shock (E mounting in track)	50G / 6 ms
Shock (G mounting)	100G / 6 ms
Maximum contact opening time under vibration and shock	10 $\mu$ s
Operate time at nominal voltage @ 25°C	4 ms max
Release time at nominal voltage @ 25°C	4 ms max
Contact make bounce at nominal voltage @ 25°C	0.5 ms max
Contact release break bounce at nominal voltage @ 25°C	0.1 ms max [7]
Weight, maximum	0.034 lbs.

Unless otherwise noted, the specified temperature range applies to all relay characteristics.

Dimensions in inches  
Tolerances, unless otherwise specified, ± 0.03 in

## MOUNTING STYLES

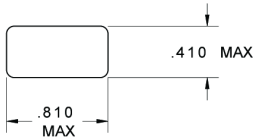

RELAY HEIGHT MAY BE INCREASED  
.100 INCH FOR "N" SUPPRESSED COILS

### MOUNTING STYLE A

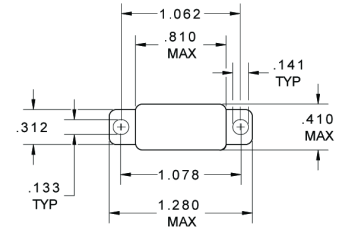
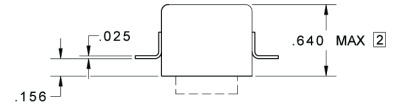

RELAY HEIGHT MAY BE INCREASED  
.100 INCH FOR "N" SUPPRESSED COILS

### MOUNTING STYLE D

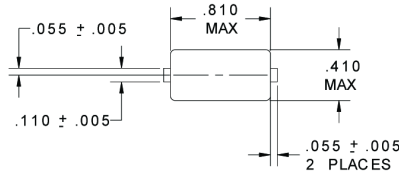
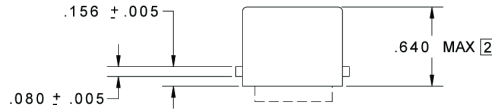

RELAY HEIGHT MAY BE INCREASED  
.100 INCH FOR "N" SUPPRESSED COILS

### MOUNTING STYLE E

#### NOTES:

FOR USE WITH TRACK MOUNT  
SYSTEM, MT- 3000- 003 AND  
SM- 1000- 003

SILICONE GASKET NOT PROVIDED  
ON THIS MOUNTING STYLE.

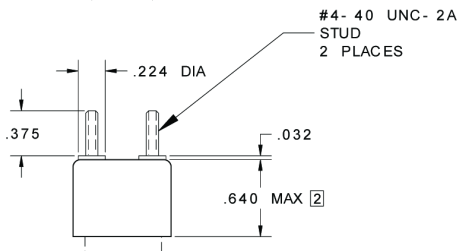
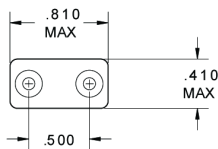

RELAY HEIGHT MAY BE INCREASED  
.100 INCH FOR "N" SUPPRESSED COILS

### MOUNTING STYLE G

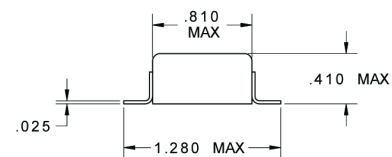
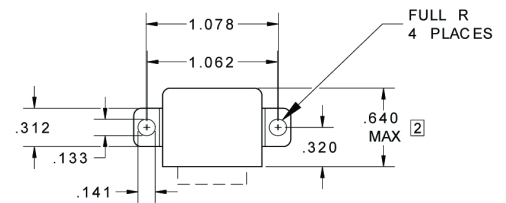

RELAY HEIGHT MAY BE INCREASED  
.100 INCH FOR "N" SUPPRESSED COILS

### MOUNTING STYLE J

Dimensions in inches  
Tolerances, unless otherwise specified, ± 0.03 in

## TERMINAL TYPES

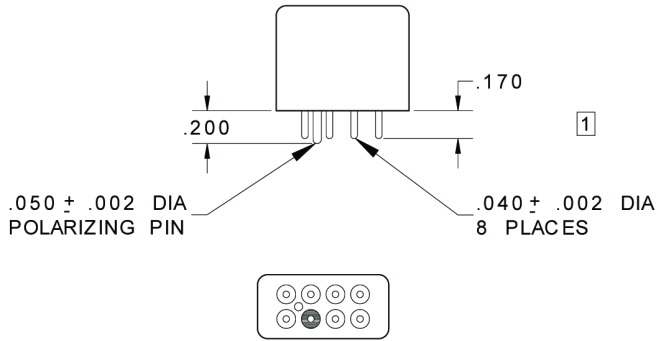

1 INSULATOR P/N RC- RP800050- 3 AVAILABLE FROM ROBISON ELECTONICS, SAN LUIS OBISPO, CA

### TERMINAL TYPE 1

FINISH:  
BODY - TIN/ LEAD  
TERMINALS - TIN/ LEAD

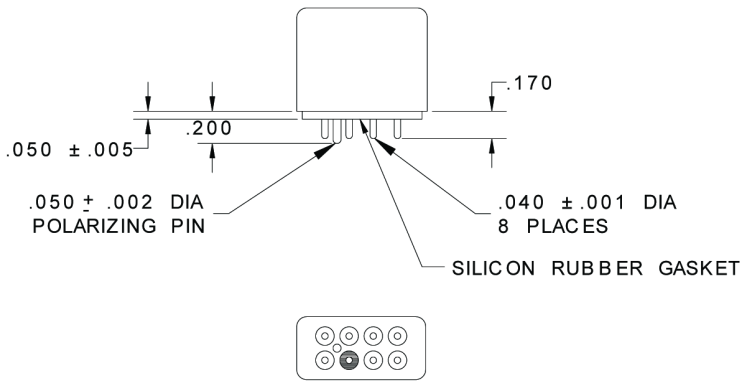

### TERMINAL TYPE 4

FINISH:  
BODY - TIN/ LEAD  
TERMINALS - GOLD PLATED

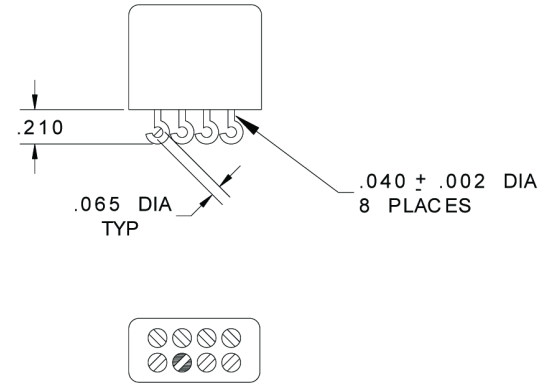

### TERMINAL TYPE 2

FINISH:  
BODY - TIN/ LEAD  
TERMINALS - TIN/ LEAD

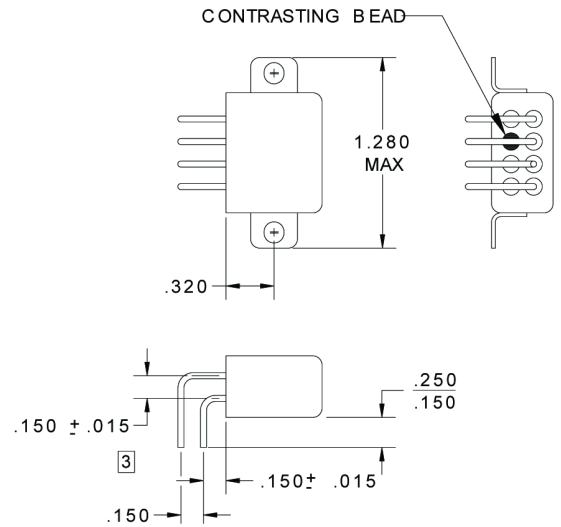

3 THIS END OF THE PIN WILL LIE WITHIN A CIRCULAR TOLERANCE ZONE; THE DIAMETER OF WHICH WILL BE 0.100 (8 PLACES).

### TERMINAL TYPE 7

FINISH:  
BODY - TIN/ LEAD  
TERMINALS - TIN/ LEAD

Dimensions in inches  
Tolerances, unless otherwise specified, ± 0.03 in

## DIAGRAMS

### SCHEMATIC DIAGRAM

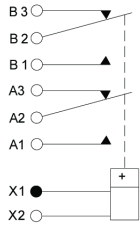

### WIRING DIAGRAM

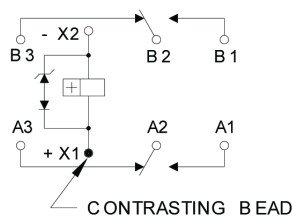

### STANDARD TERMINAL LAYOUT

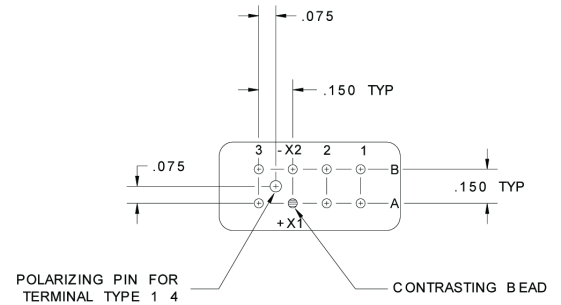

TOL: .XX ±.03; .XXX ±.010

## NUMBERING SYSTEM

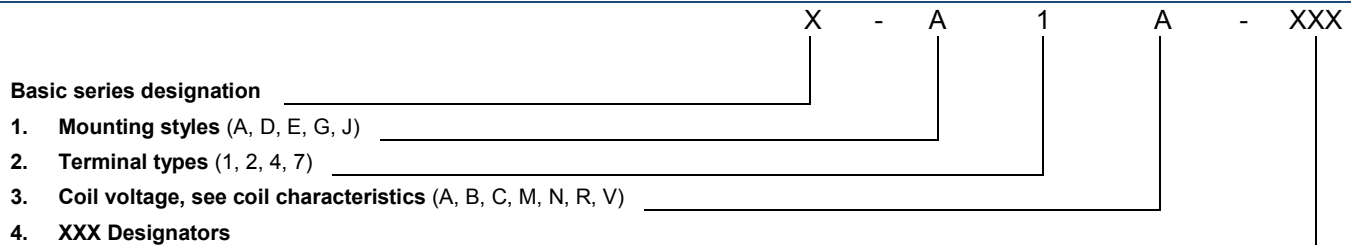

## NOTES

- Standard Intermediate Current test applicable
- Inductive load life: 20,000 cycles.
- Low level endurance test: contact load of 10 to 50 millivolt, 10 to 50 microamp, 100 Ohm max. contact resistance.
- Refer to MIL-PRF-83536/1 & /2 for details.
- "N" "R" & "V" coils have back EMF suppression to 42 volts maximum.
- 500 Vrms with silicone rubber gasket compressed, 250 Vrms all other conditions.
- Applicable to Type "N", "R" & "V" coils only.
- Relay will not operate, but will not be damaged by application of reverse polarity on coil.
- Capacitive loads not applicable.

For any inquiries, please contact your local sales representative: leachcorp.com